

# MESA DALLAS

## Esquema de Montagem

1

Fixar o comp. H com o componente B na peça 5, nos Pontos de fixação.



2

Pontos de fixação

Fixar o comp. H nas peças 2 e 3 nos pontos de fixação

Parafusar nos furos menores marcados pelas setas

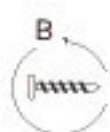

E

F

4

3

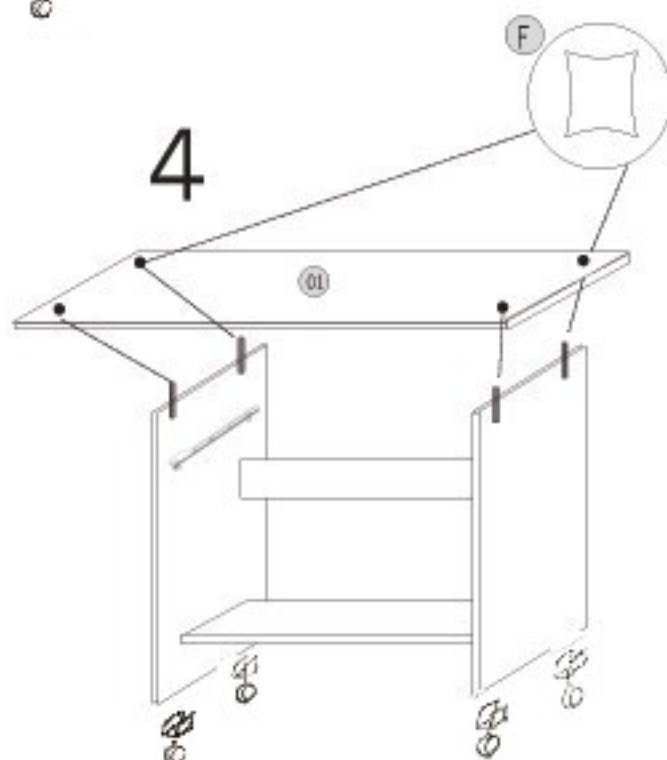
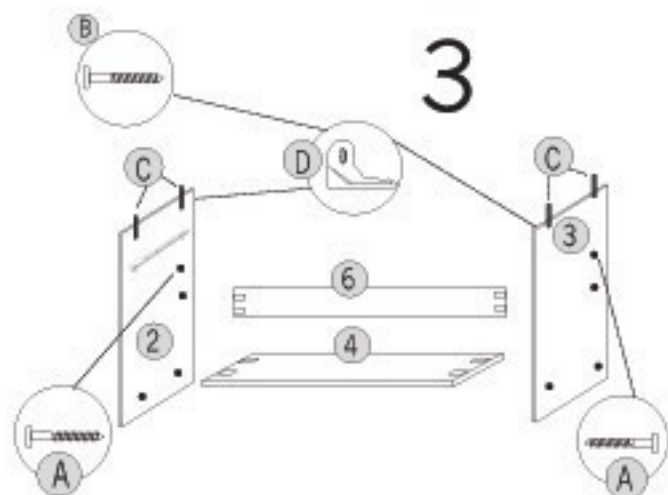

## Componentes

A (8) 

E (4) 

B (28) 

F (1) 

C (4) 

G (4) 

D (2) 



**TECLA**

Móveis para  
Informática  
e para o lar

SAC (011) 6422-8002  
www.tecla-net.com.br  
e-mail: tecla.comercial@uol.com.br